

EH50 TIRM Thermal Camera

User Manual

V1.0

2022.5

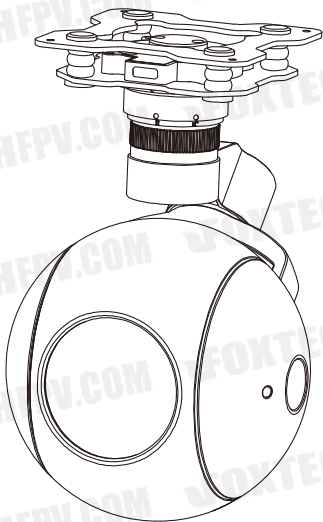

 **FOXTECH**





1. Product Introduction

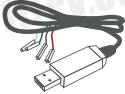

1.1 Introduction

EH50 is a high-precision 3-axis gimbal integrated with a 50mm lens 640*480 IR thermal sensor. It supports IR thermal image switch, IR color palette switch, photographing and video, target tracking and thermal digital zoom. OSD can display angle, digital zoom times, status of record and picture mode, tracking frame, also can select to turn off the OSD. When the external GPS and time input, GPS coordinate and shooting time can be saved in image file, OSD can display GPS and real-time as well. The 3 axis gimbal can achieve stabilization in yaw, roll and pitch. The integrated design of damping system and gimbal can greatly reduce mechanical vibration.

EH50 is widely used in UAV industries of public security, electric power, fire fighting, zoom aerial photography and other industrial applications.

1.2 In the Box

Gimbal Camera x 1 pc		USB to TTL Cable x 1 pc	
Copper Cylinder x 4 pcs		M3 Screw x 8 pcs	
Power Cable x 1 pc			
PWM Control Cable x 1 pc			

TTL / S.BUS Control Cable x 1 pc	
TTL Connect Cable x 3 pcs	
Ethernet Cable x 1 pc	

2. Installation Instruction

2.1 Overview

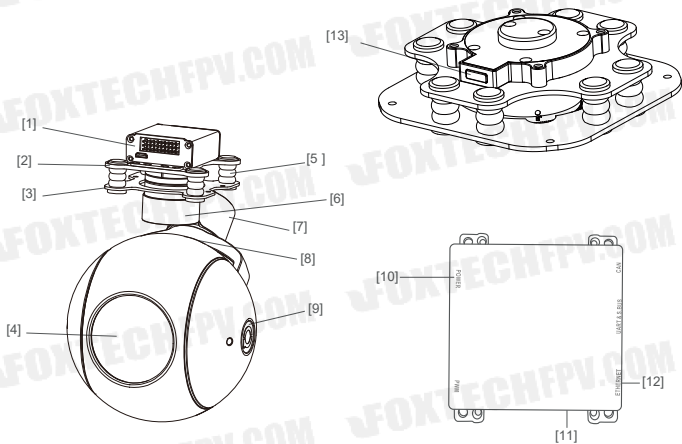

[1] Control box	[8] TF card slot
[2] Upper damping board	[9] Pitch axis motor
[3] Lower damping board	[10] 3-6S power interface
[4] Infrared thermal camera	[11] Micro HDMI interface
[5] Damping ball	[12] Ethernet interface
[6] Yaw axis motor	[13] Unlock button
[7] Roll axis motor	



- Please ensure that there isn't any obstacle while the motor rotating.
- Please remove the obstacle immediately if gimbal camera is blocked during rotation.



- Don't put the infrared thermal camera towards the sun in case any burn to the camera

2.2 Control Box Printing



Front Side

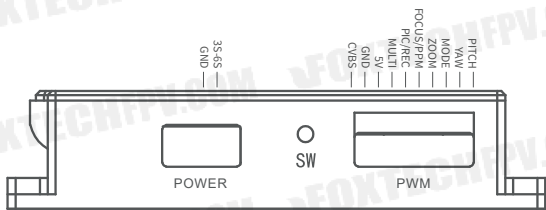

Left Side

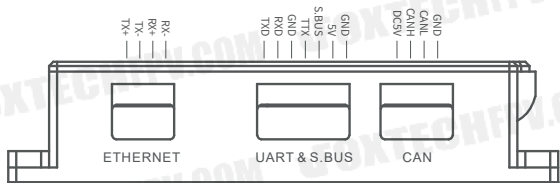

Right Side

2.3 Device Dimensions

Unit: mm

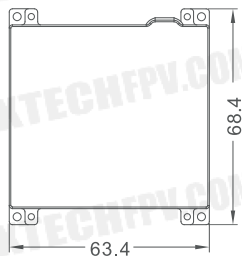
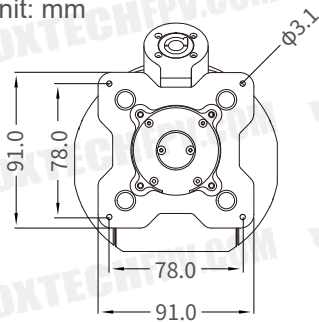

Control Box

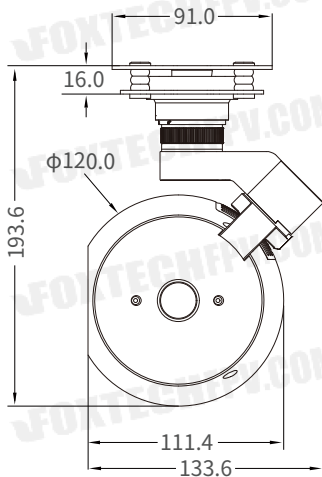
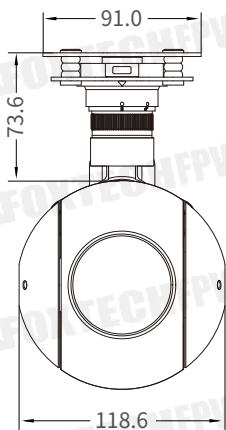

2.4 Install Mounting Part

- (1) Find out the arrow on the gimbal which indicating the yaw heading of the payload (i.e. the lens direction when the camera power on), and synchronize with the direction specified by the UAV.
- (2) Fix one end of the copper cylinder on the screw hole of lower damping board, and use M3 screw to fasten it.
- (3) According to the provided screw hole dimension you can make suitable mounting holes on the UAV mounting board, and fixes the other end of the copper cylinder on the mounting board of the UAV.

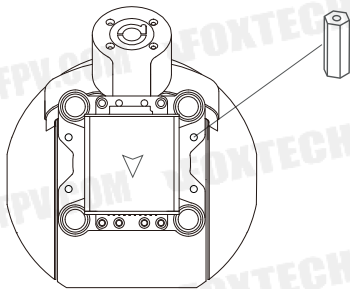

Front

2.5 Quick-mount Release Instruction

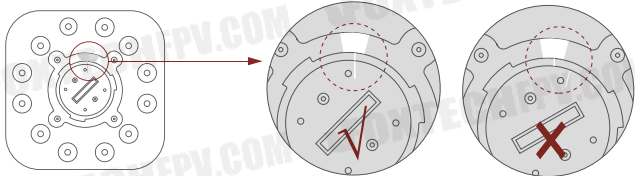
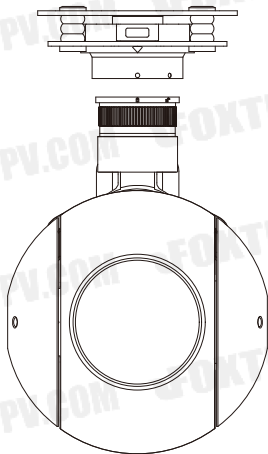

1. Make sure the two white stripes indicated in above picture are aligned with each other. (If the stripes are not aligned to each other, please pinch the connector part and turn it to left manually)

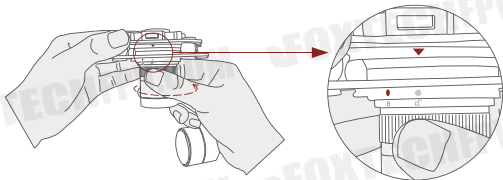

2. Align the white dot (unlock icon) to the red triangle (below unlock button), push the gimbal into the board completely and then rotate the gimbal camera anticlockwise.

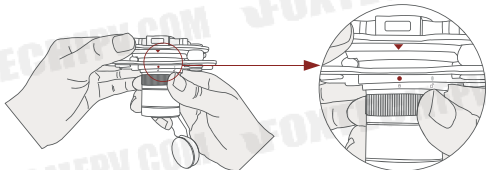

3. When you hear "click" sound (when red dot is aligned to the red triangle) means the gimbal camera and the board has been locked.

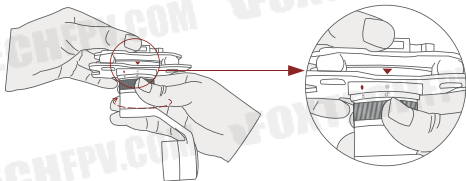

4. To unlock the gimbal, you need to press on unlock button and rotate the gimbal camera clockwise till the white dot align to the red triangle. Then pull the gimbal out from the board.

2.6 Install TF Card

TF (Micro SD card): Install the TF card to the card slot (Re. 2.1 Overview). Support max 128GB. Request Class 10 (10m/s) transmission speed or higher and FAT32 or exFAT format.



- Make sure device is power off when inserting the TF card, hot plugging is not supported.

2.7 Image Output Interface

HDMI: micro HDMI output, HD 1080P 60/50/30/25fps, 1080P 60fps as default. (Optional)

Network: Ethernet output interface, support RTSP/RTMP/UDP/ON-VIF video streaming. Default: RTSP output, IP address: RTSP://192.168.2.119:554, output resolution: 720P (record in 1080p), frame rate: 25fps, bit rate: 2M. (Optional)

SDI: SMA outer screw inner hole interface, 1080P 30fps output. (Optional)

AV: no AV output

- Above output mode is optional, HDMI and SDI output cannot coexist at the same time. Please subject to your actual product.
- When using user interface software Viewlink for network connection, the network of external device (computer) should be the IP address: 192.168.2.2 (choose the last byte among 2~254, can not be 119 same as the gimbal), subnet mask: 255.255.255.0, Default gateway: 192.168.2.1, and all firewalls of the computer must be closed. Then enter the IP address of the gimbal camera, Open Video, the video stream can be outputted.



3. Signal Control

3.1 PWM Control

Control the gimbal camera functions by the multiplex pulse width modulation signal outputted by PWM channel of the remote control receiver. The camera needs up to 6 control channels of PWM (to expand tracking function use up to 7 PWM channels). You can choose needed functions according to actual usage to reduce the required number of PWM channels.

3.1.1 PWM Connection Diagram (Connect pitch channel as example)

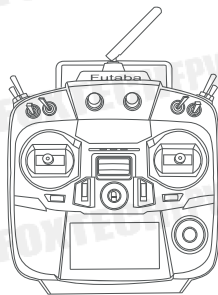

Remote Controller

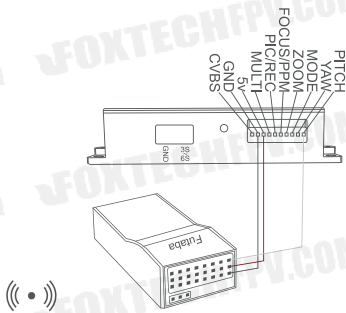

Receiver

Connection Diagram

3.1.2 PWM Control Operation Instruction

1) Pit (PWM Pitch channel in to control Pitch. Joystick, rotary knob or 3-gear switch on remote control are optional. 3-gear switch as example.)



Position 1

Low Gear
Pitch Up



Position 2

Middle Gear
Pitch Stop



Position 3

High Gear
Pitch Down

2) Yaw (PWM Yaw channel in to control Yaw. Joystick, rotary knob or 3-gear switch on remote control are optional. 3-gear switch as example.)



Position 1

Low Gear
Yaw Left



Position 2

Middle Gear
Yaw Stop



Position 3

High Gear
Yaw Right

3) Mode (PWM Mode channel in to adjust speed control/one key to Home position etc functions. Rotary knob or 3-gear switch on remote control are optional. 3-gear switch as example.)



Position 1

Low Gear



Position 2

Middle Gear



Position 3

High Gear

Position 1: Low speed mode, control pitch / yaw with this mode at lowest speed

Position 2: Middle speed mode, control pitch / yaw with this mode at middle speed

Position 3: High speed mode, control pitch / yaw with this mode at highest speed

(If it is controlled by rotary knob, the speed will change according to switch position)

Function of continuous switching:

3.1) Operate 1 time continuously and quickly, from position 2 - 3 - 2, to Home position.

3.2) Operate 2 times continuously and quickly, from position 2 - 3 - 2 - 3 - 2, the camera lens looks vertically down.

3.3) Operate 3 times continuously and quickly, from position 2 - 3 - 2 - 3 - 2 - 3 - 2, to disable Follow Yaw Mode (gimbal yaw not follows by frame)

3.4) Operate 4 times continuously and quickly, from position 2 - 3 - 2 - 3 - 2 - 3 - 2 - 3 - 2, to enable Follow Yaw Mode (gimbal yaw follows by frame)

4) Zoom (PWM Zoom channel in to control Zoom. Joystick, rotary knob or 3-gear switch on remote control are optional. 3-gear switch as example.)



Position 1

Low Gear
IR digital zoom



Position 2

Middle Gear
No control



Position 3

High Gear
IR color palette switch

Switch from Position 2 to 1: IR color switching: white hot, black hot, pseudo color.

Switch from Position 2 to 3: IR digital zoom: 3x, 6x, 9x, 12x.

5) Focus (PWM Focus channel is to control IR color palette switch. 3-gear switch as example.)



Position 1

Low Gear
No control



Position 2

Middle Gear
No control



Position 3

High Gear
IR color palette switch

Switch from Position 2 to 3: IR color switching: white hot, black hot, pseudo color.

6) Pic/Rec (PWM Pic/Rec channel in to control take picture and record. Joystick, rotary knob or 3-gear switch on remote control are optional. 3-gear switch as example.)



Position 1

Low Gear



Position 2

Middle Gear



Position 3

High Gear

Switch from Position 2 to 1: Take a picture

- OSD display 'REC IMG' a second.

Switch from Position 2 to 3: Start record / repeat operation to stop record

- Start record, the OSD display rec hh:mm:ss.
- Stop record, the OSD display STBY.

7) Multi: tracking control



Position 1

Low Gear



Position 2

Middle Gear



Position 3

High Gear

Switch from Position 2 to 1: Cancel tracking

Switch from Position 2 to 3:

- Exit the tracking, display the lock frame in the center of the screen, start tracking

Switch from Position 3 to 2:

- "+" appears in the center of the screen, adjust the cross cursor UDLR with yaw and pitch control to lock target object

Switch from Position 2 to 3 again:

- Choose another target for second tracking

Diagram of USB to TTL Cable:

Connect the camera to the upper computer by USB to TTL cable (Adopt connection method of TX to RX, RX to TX, GNG to GND at Dupont ends of the provided USB to TTL cable, connect to the specified TTL of the gimbal, and the USB end of the cable connect to computer).

Install Viewlink control software to test the functions directly. Users may choose to develop their own software, please contact technical support for TTL control protocol file.



- Connect serial port of gimbal to pins, DO NOT connect with power supply.



- The default baud rate of serial port is 115200, which can be changed according to the docking equipment.
-

3.3 S.BUS Control

Control the gimbal camera functions by one combining signals. Connect the external S.Bus to S.Bus port on the control box, and the external S.bus signal GND connect to the GND interface of the control box.

Wiring Diagram (Take Futaba remote control for example):

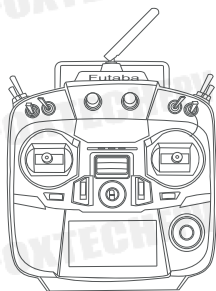

Remote Control



Receiver

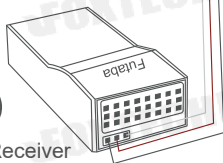

Wiring Diagram

S.Bus control mode: default S.Bus signal channel 9-15 to control gimbal camera functions (the function of channel is consistent with corresponding channel in PWM function description)

Channel 9: Yaw Control

Channel 10: Pitch Control

Channel 11: Mode Control

Channel 12: Zoom Control

Channel 13: Focus Control

Channel 14: Pic/Rec Control

Channel 15: Multi Backup



• User can set the channels by setting serial command according to the actual requirement. The S.Bus channel position can be arranged in any sequence within channel 1-15 to connect with the flight controller or remote control.

• TTL control and S.bus control cannot coexist at the same time for standard version. The default control is TTL if no requirement. The user can set to S.bus control if needed (please contact with our technical support for the setting instruction.)

3.4 TCP control

For cameras with Ethernet output, the default IP address is: 192.168.2.119, control port: 2000. You can send the corresponding protocol to realize TCP control after connecting.

The TCP control protocol is [Frame header: EB + command ID: 90 + data body (serial port protocol) + Checksum (CS = body checksum, checksum is calculated as a sum of all bytes of data body modulo 256)]. Or directly use UI Viewlink to control after TCP connection.

4. Specification

Hardware Parameter	
Working voltage	12V
Input voltage	3S ~ 6S
Output voltage	5V (connect with PWM)
Dynamic current	500mA~1000mA @ 12V
Idle current	500mA @ 12V
Working environment temp	-20℃ ~ +60℃
Output	micro HDMI(1080P 60fps) / IP (720p/1080p 25fps/30fps)
Local-storage	TF card (Up to 128G, class 10, FAT32 or ex FAT format)
Photo storage format	JPG(1920*1080 / 1280*720)
Video storage format	MP4 (1080P/720P 25fps/30fps)
Control method	PWM / TTL / S.BUS / TCP(IP output)
Gimbal Spec	
Mechanical Range	Pitch/Tilt: -90~120°, Roll: ±38°, Yaw/Pan: ±300° / ±360°*N (IP / SDI output version)

Controllable Range	Pitch/Tilt: $-45^{\circ} \sim 90^{\circ}$, Yaw/Pan: $\pm 290^{\circ} / \pm 360^{\circ} * N$ (IP / SDI output version)
Vibration angle	Pitch/Roll: $\pm 0.02^{\circ}$, Yaw: $\pm 0.02^{\circ}$
One-key to center	√
Thermal Imager Spec	
Lens size	50mm
Horizontal FOV	12.4
Vertical FOV	9.3
Diagonal FOV	15.5
Detective Distance (Man: 1.8x0.5m)	1471 meters
Recognize Distance (Man: 1.8x0.5m)	368 meters
Verified Distance (Man: 1.8x0.5m)	184 meters
Detective Distance (Car: 4.2x1.8m)	4510 meters
Recognize Distance (Car: 4.2x1.8m)	1127 meters
Verified Distance (Car: 4.2x1.8m)	564 meters
Working mode	Uncooled long wave ($8\mu\text{m} \sim 14\mu\text{m}$) thermal imager
Detector pixel	640*480

Pixel size	17 μ m
Focusing method	Athermal prime lens
Emissivity correction	0.01~1
NETD	$\leq 50\text{mK}$ (@25 $^{\circ}\text{C}$)
MRTD	$\leq 650\text{mK}$ (@characteristic frequency)
Image enhancement	Auto adjust image brightness and contrast ratio
Color palette	White, iron red, pseudo color
Auto Non-uniform correction	Yes (no shutter)
Digital zoom	3X, 6X, 9X
Sync correct time	Yes
Thermometry type	Temperature bar (psudo color display) max temp, min temp, FOV center temp (Optional)
Temperature warning	0 $^{\circ}\text{C}$ ~120 $^{\circ}\text{C}$ (For thermometry version only)

Thermal Imager Object Tracking

Update rate of deviation pixel	50Hz
Output delay of deviation pixel	5ms
Minimum object size	32*32 pixel
Maximum object size	128*128 pixel

Tracking speed	32 pixel/frame
Object memory time	100 frames (4s)
Packing Information	
N.W.	948g
Product meas.	118.6*133.6*193.6mm
Accessories	1pc gimbal camera device, screws, copper cylinders, damping balls, damping boards, 1pc USB to TTL cable / box

5. FAQ

1. Does EH50 support taking photos during recording?

A: Yes.

2. How to set the storage format of EH50?

A: When the IP output resolution is set to 1280*720, the storage resolution is 1920 * 1080; Storage resolution is 1280 * 720 when the IP output resolution is set to 1920*1080; The video frame rate saved in the TF card is the same with the one set during IP output. The frame rate is 25fps or 30fps for optional.

3. Does EH50 support simultaneous TCP control for multiple devices?

A: Yes